



TECHNICAL MANUELS

January, 2021
6000 Series



ER 6001

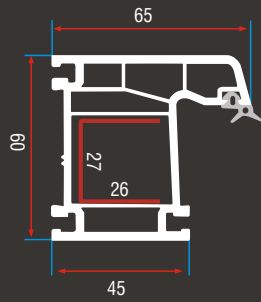

ER 6002

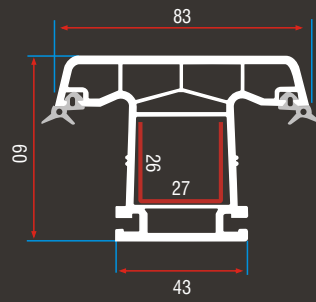

ER 6003

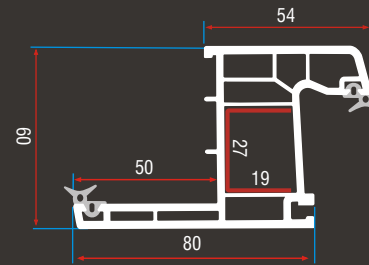

ER 6004

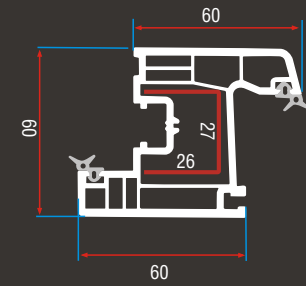

ER 6005

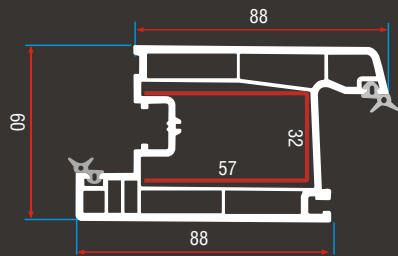

ER 6006

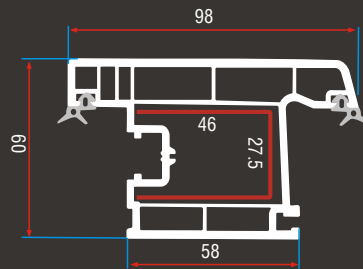

ER 7003

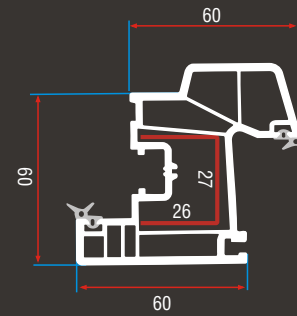

ER 6031

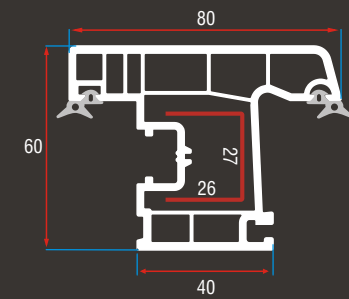

ER 6015

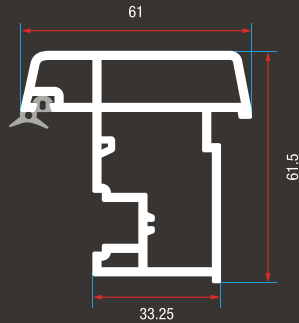

ER 6007

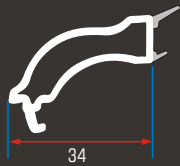

ER 6008



ER 7004



ER 6029

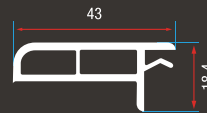

ER 6016

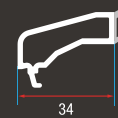

ER 6017



ER 7016



S 1021

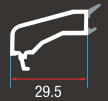

ER 6014

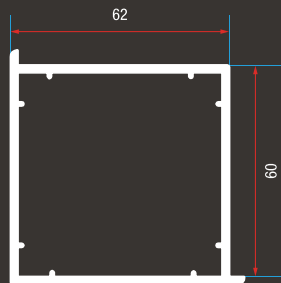

ER 6013



ER 6011

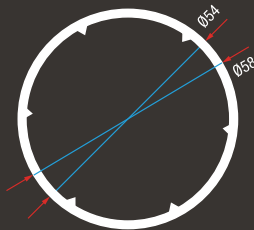

ER 6012

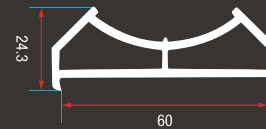

ER 6009



ER 6010

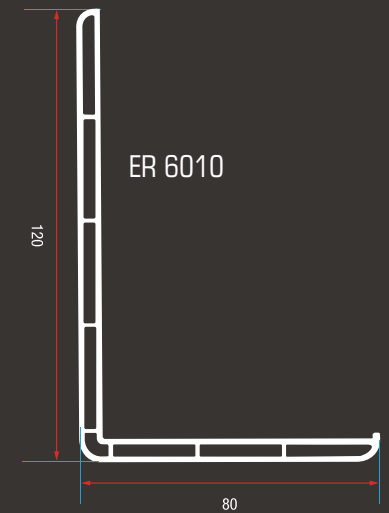

AKS 010

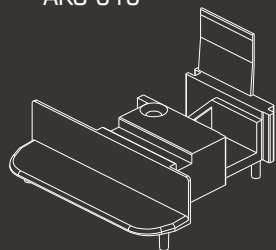

AKS 020

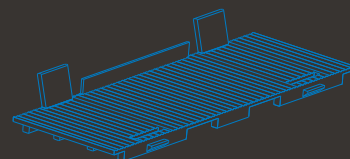

AKS 021

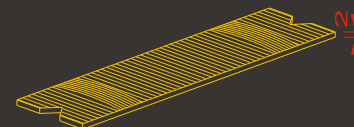

AKS 022

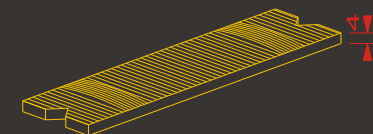

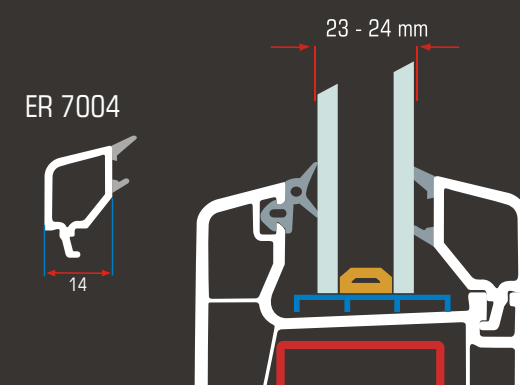
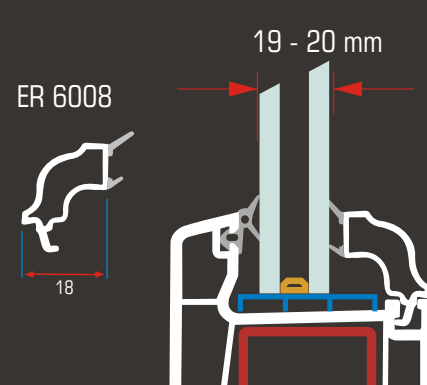
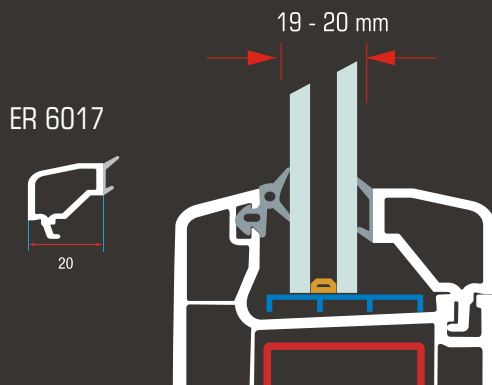
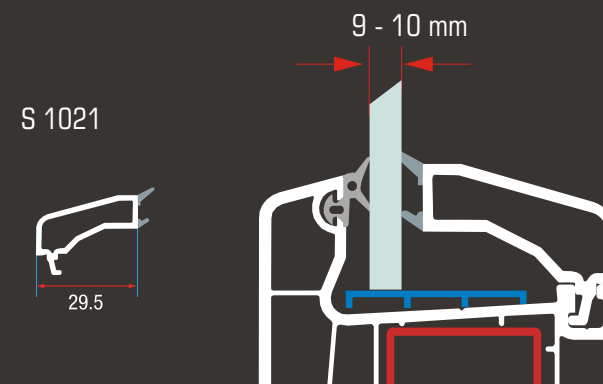
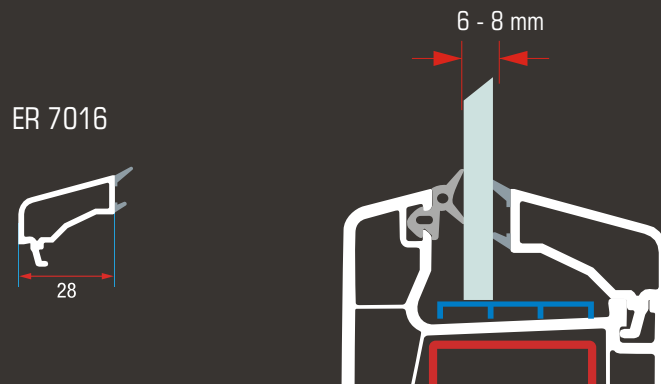
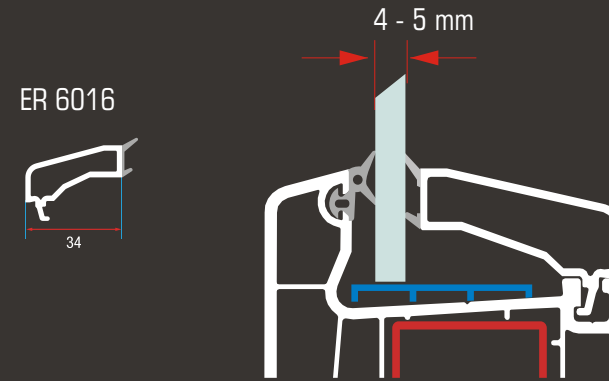
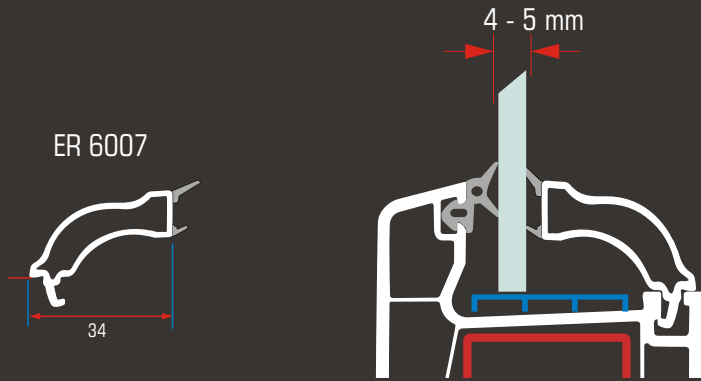

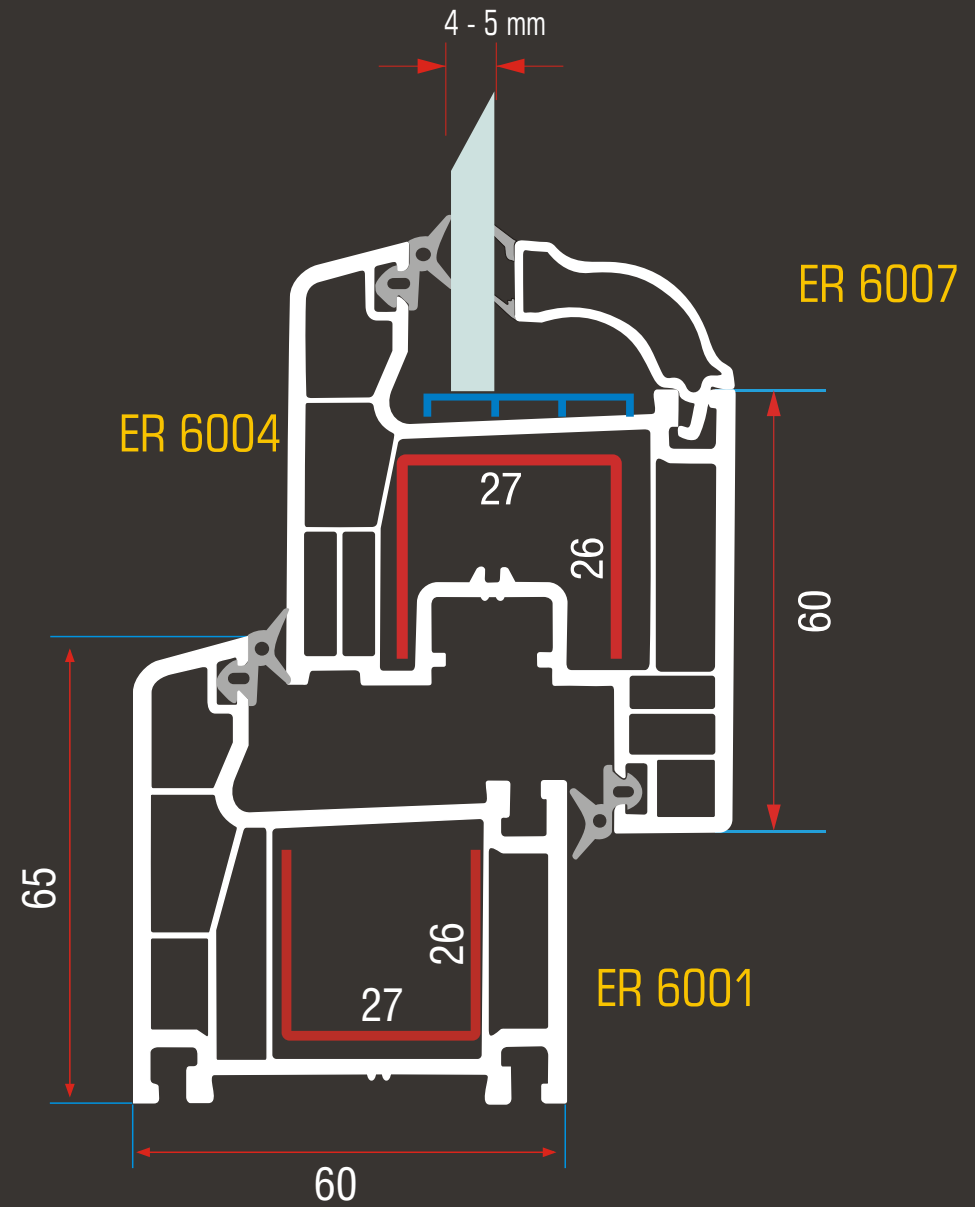
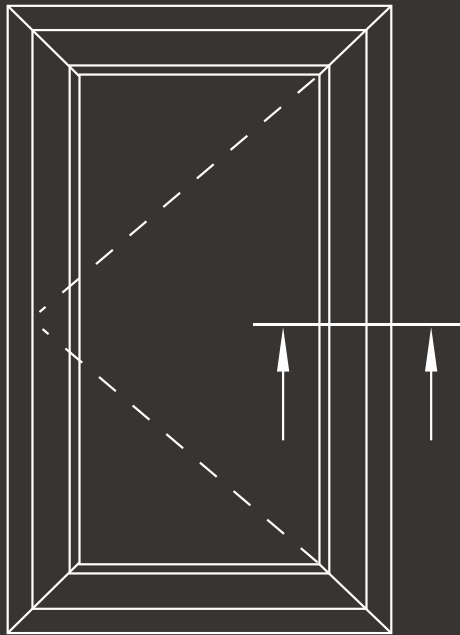

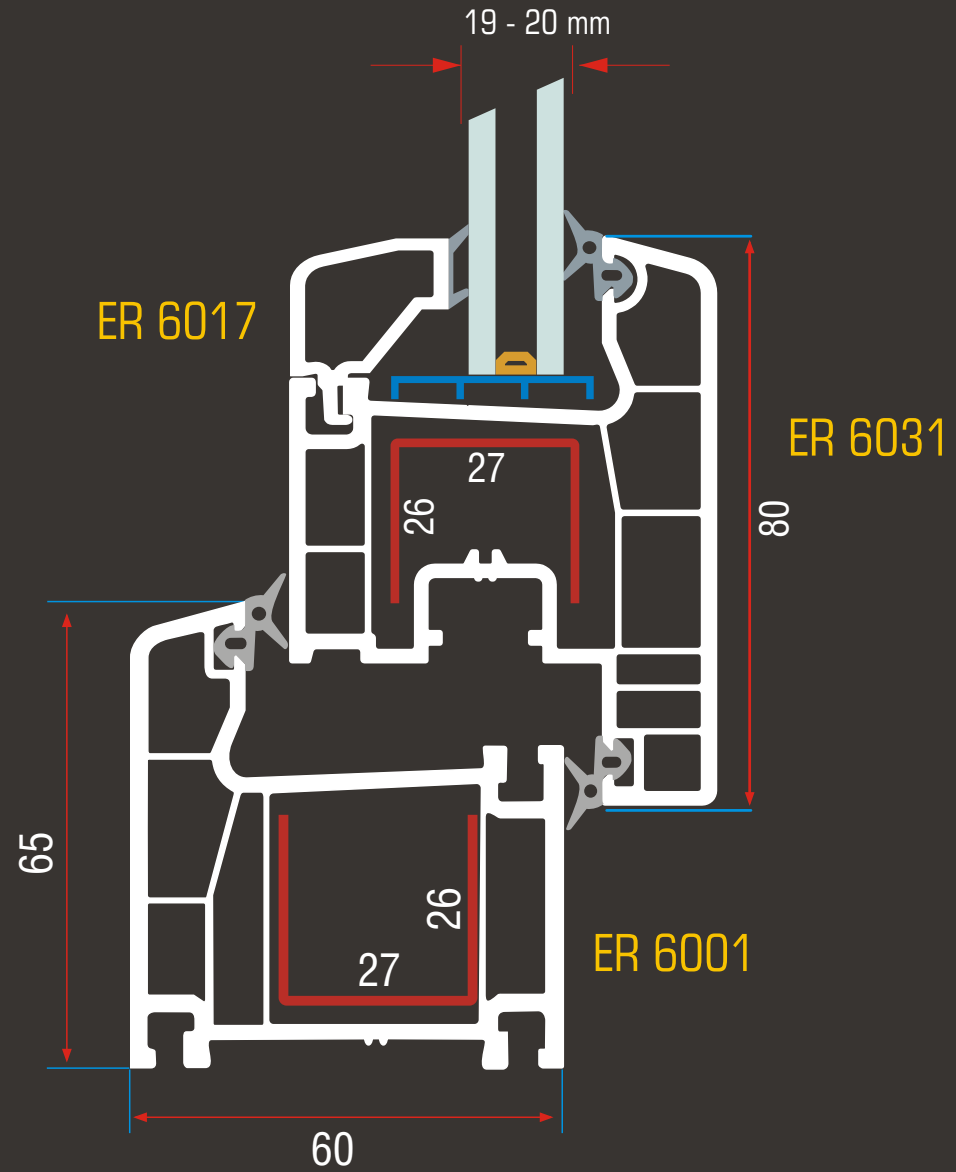
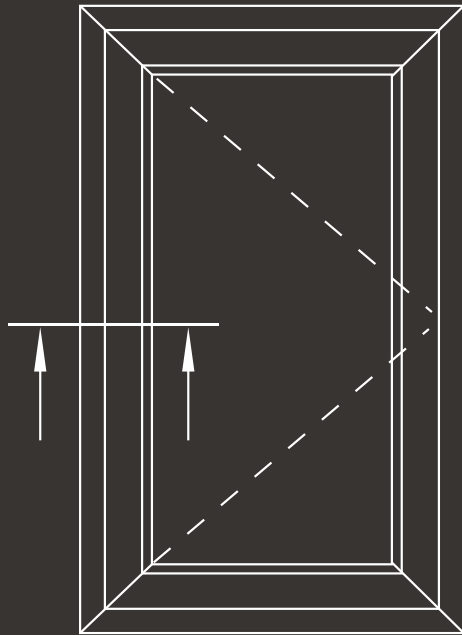

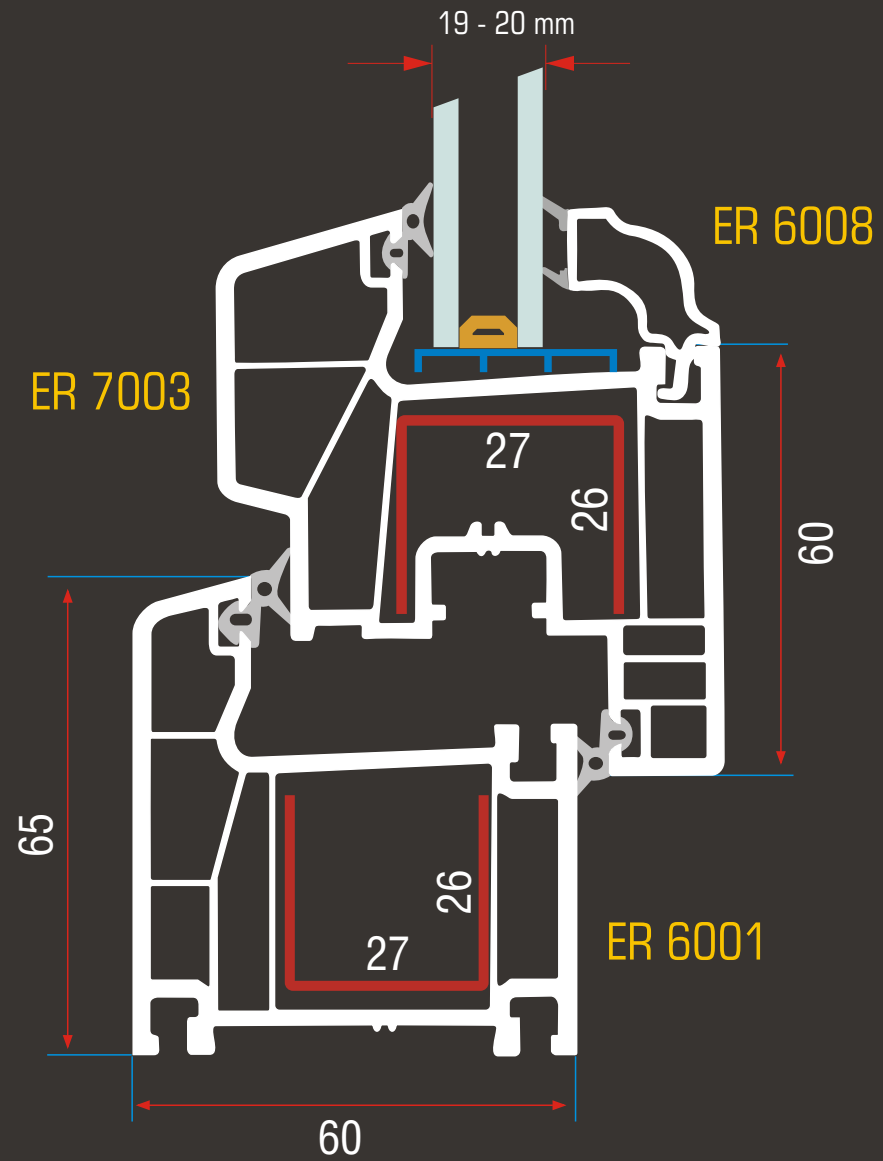
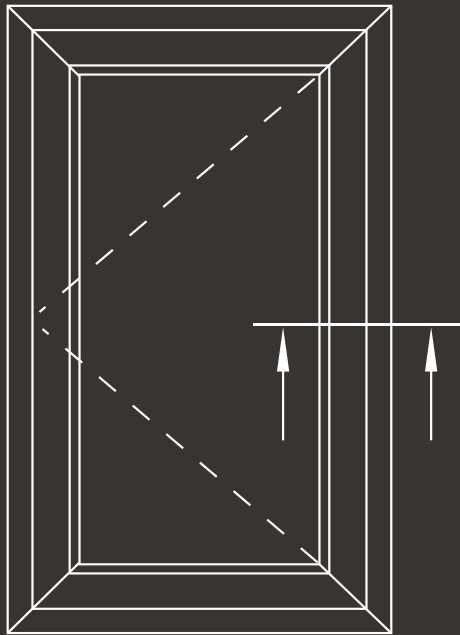

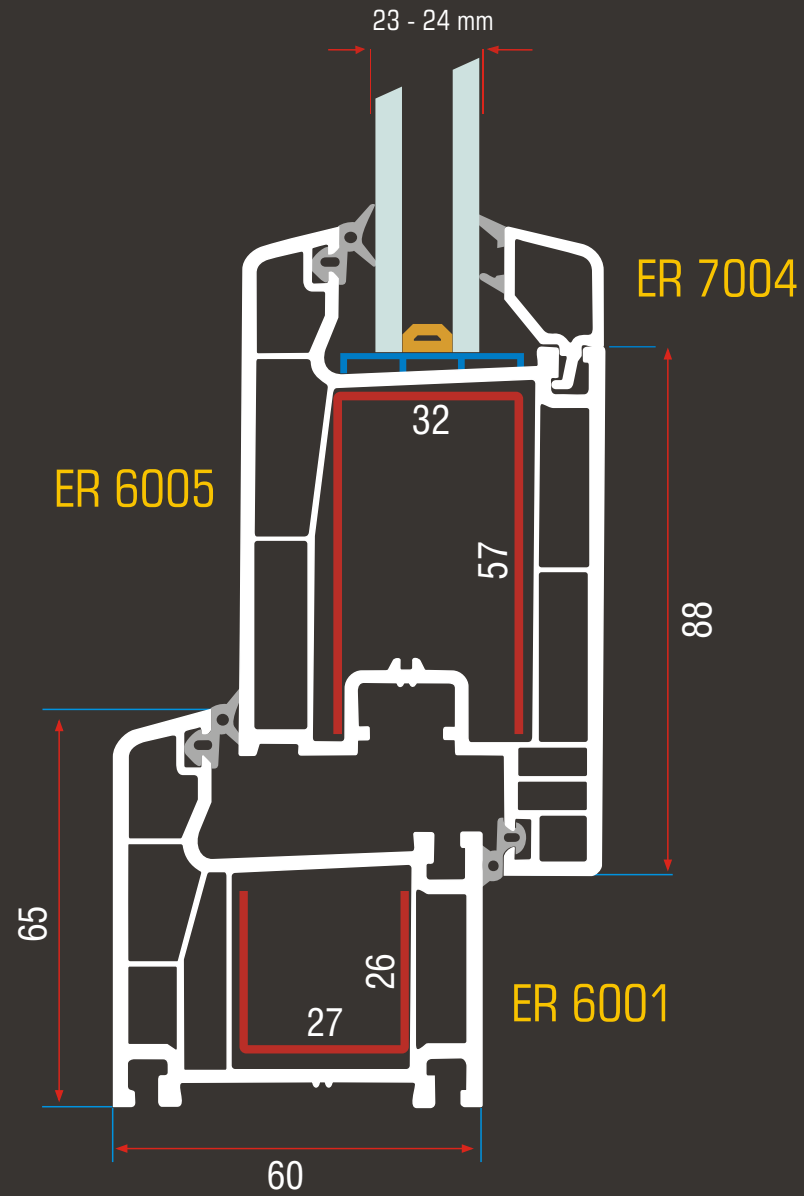
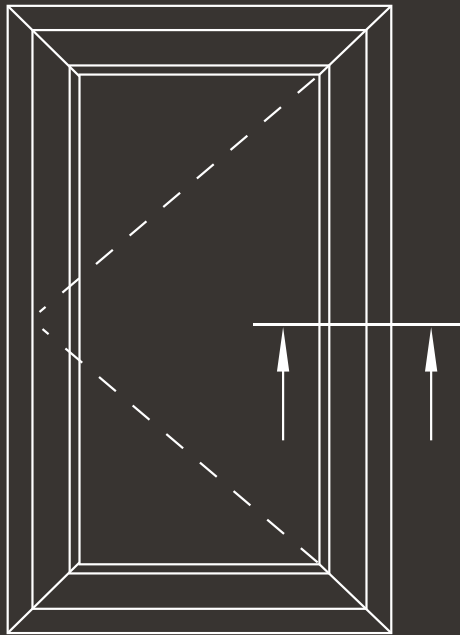

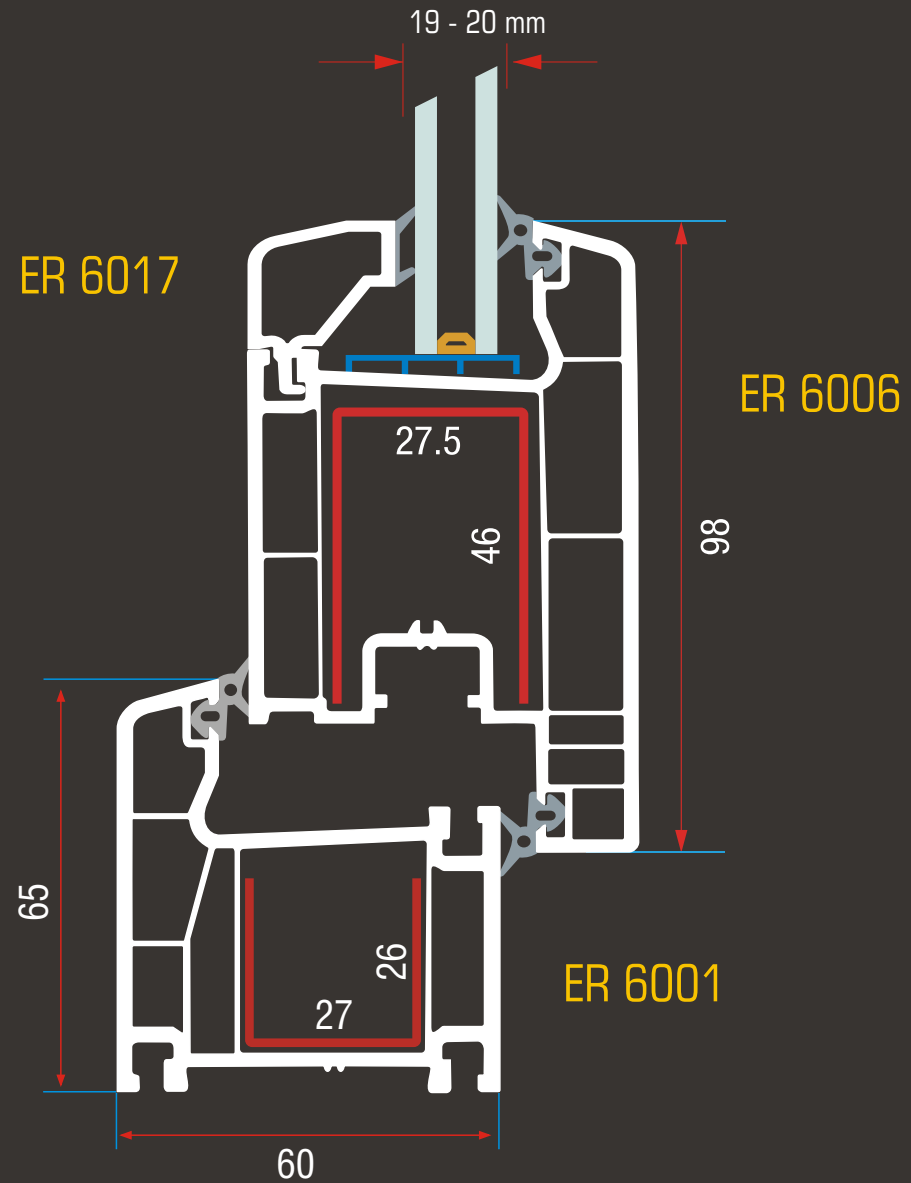
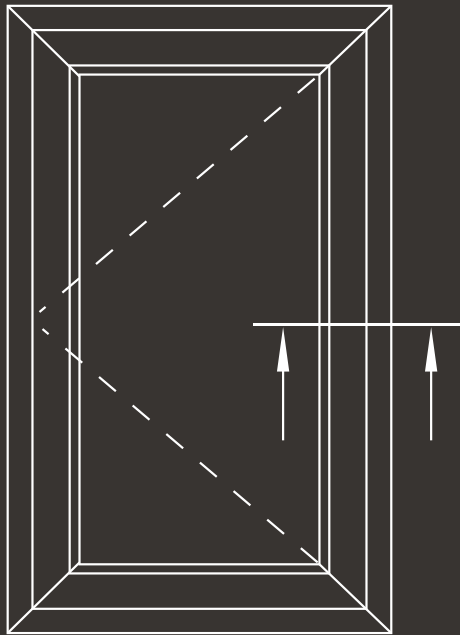

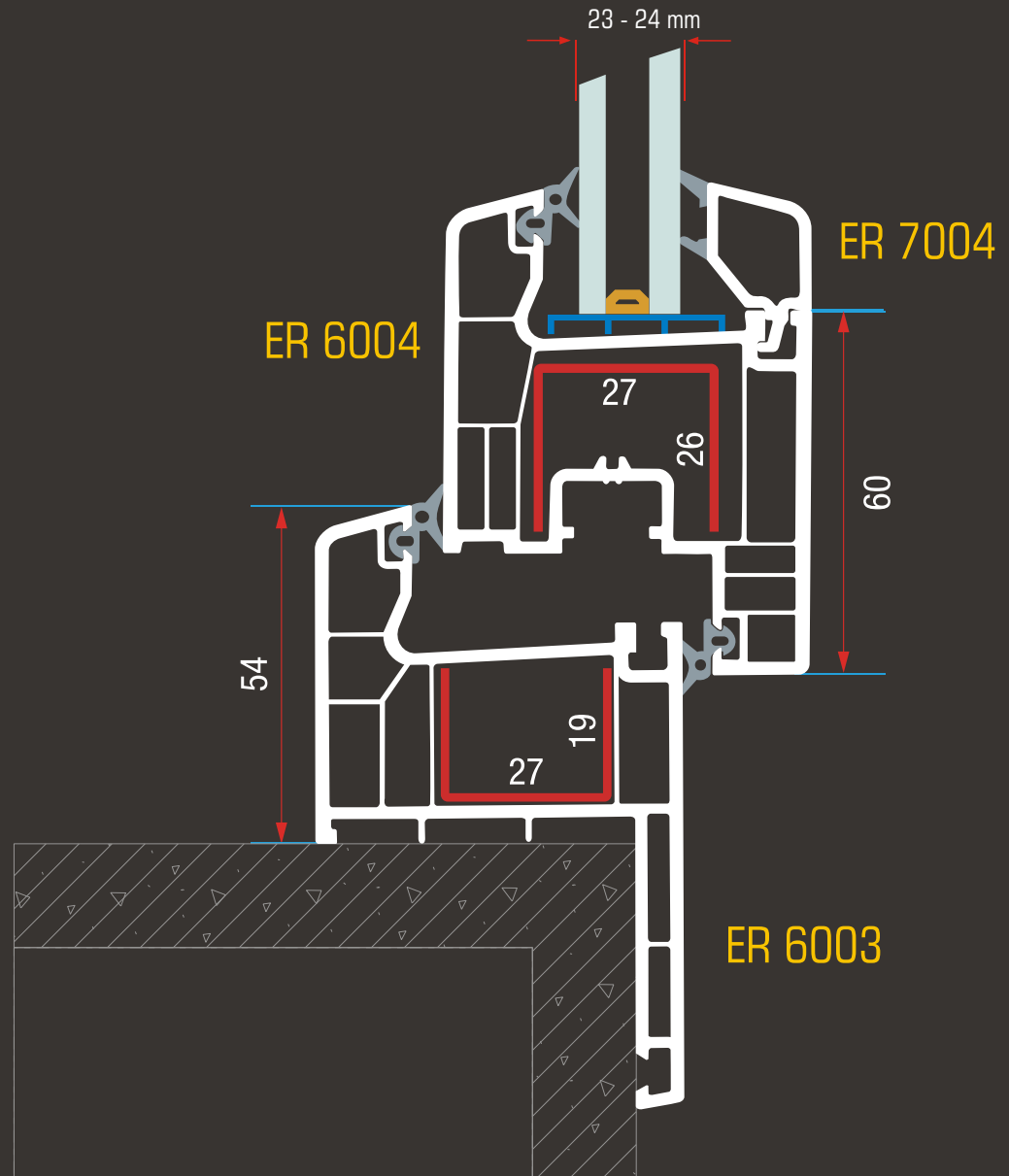
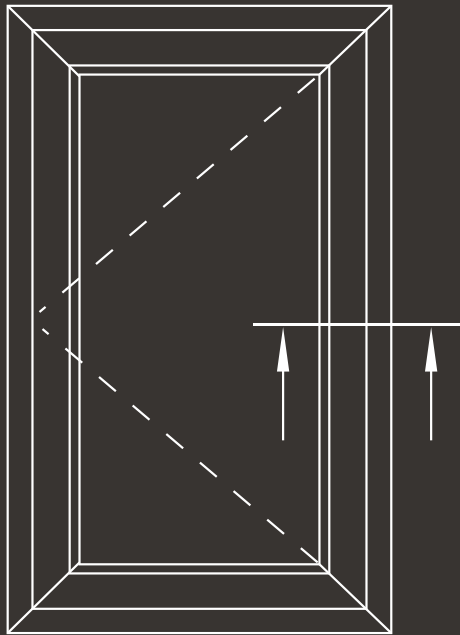

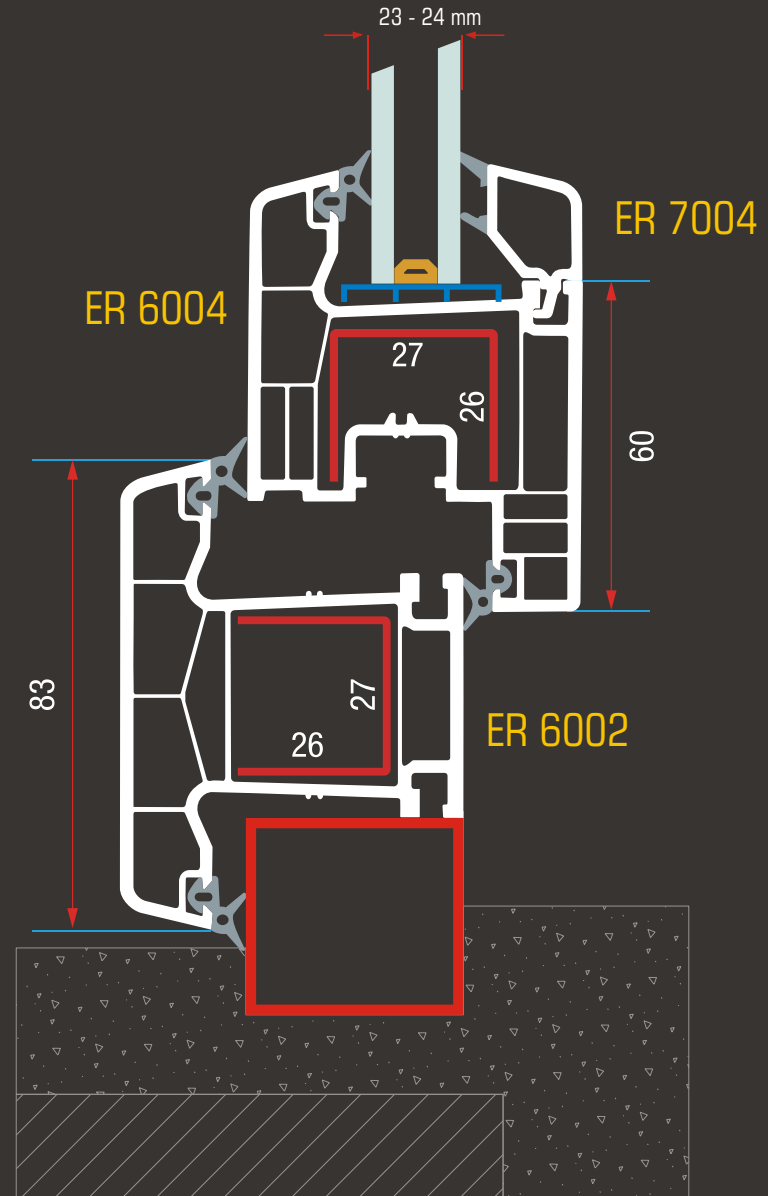
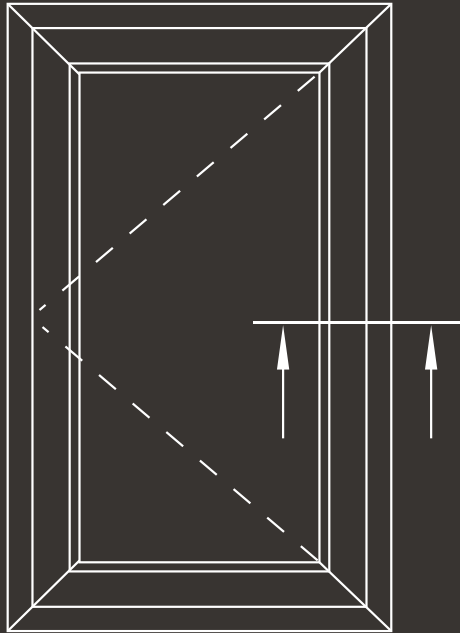

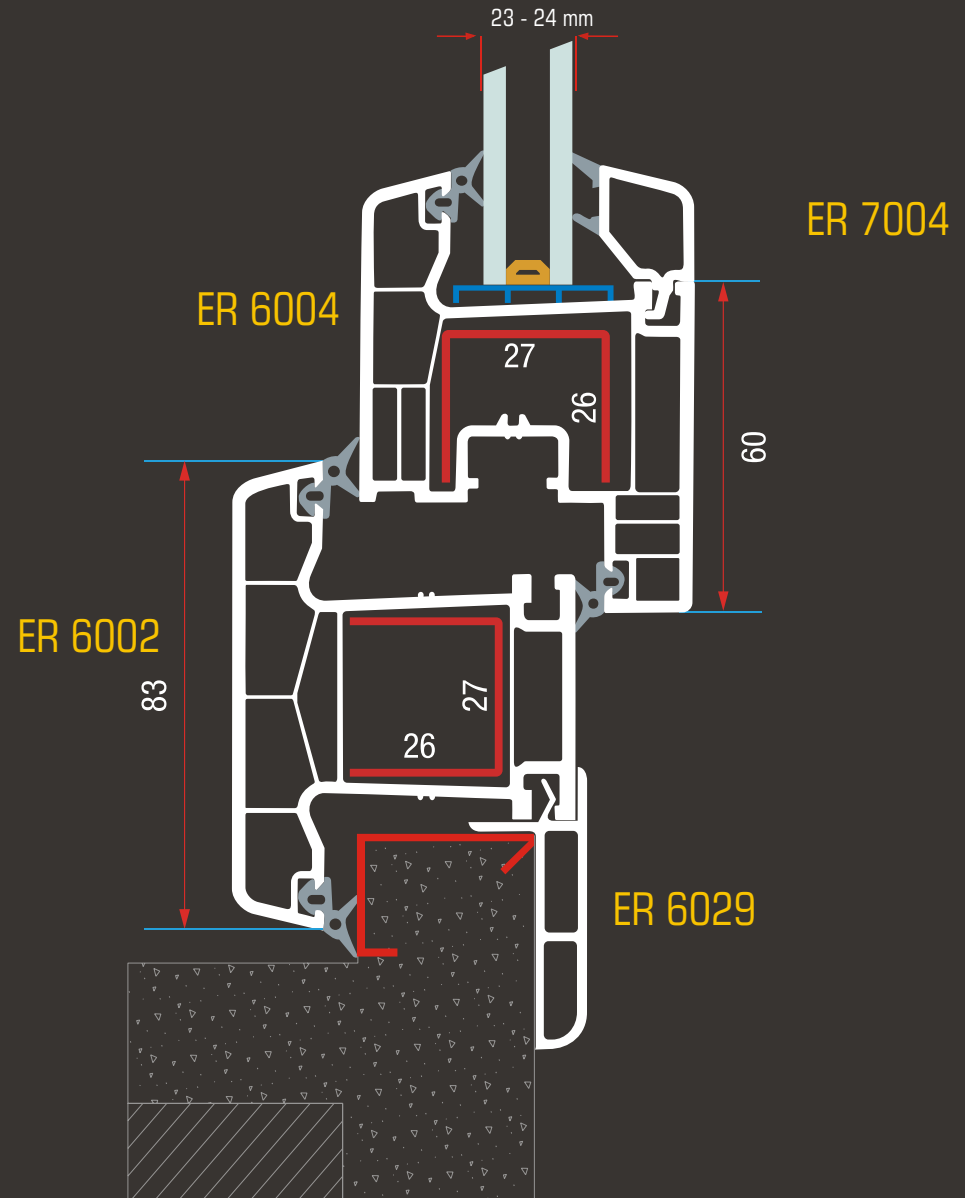
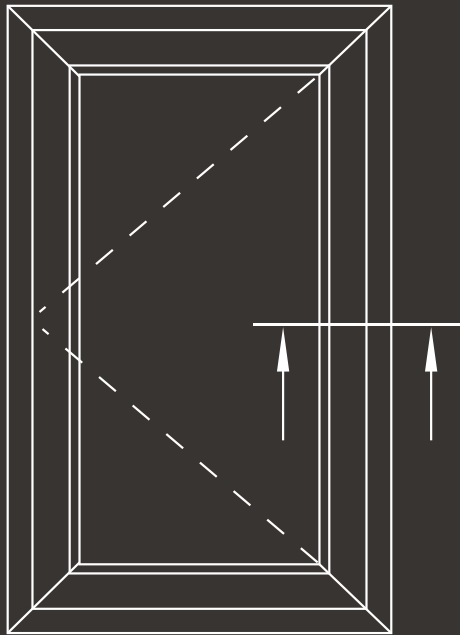

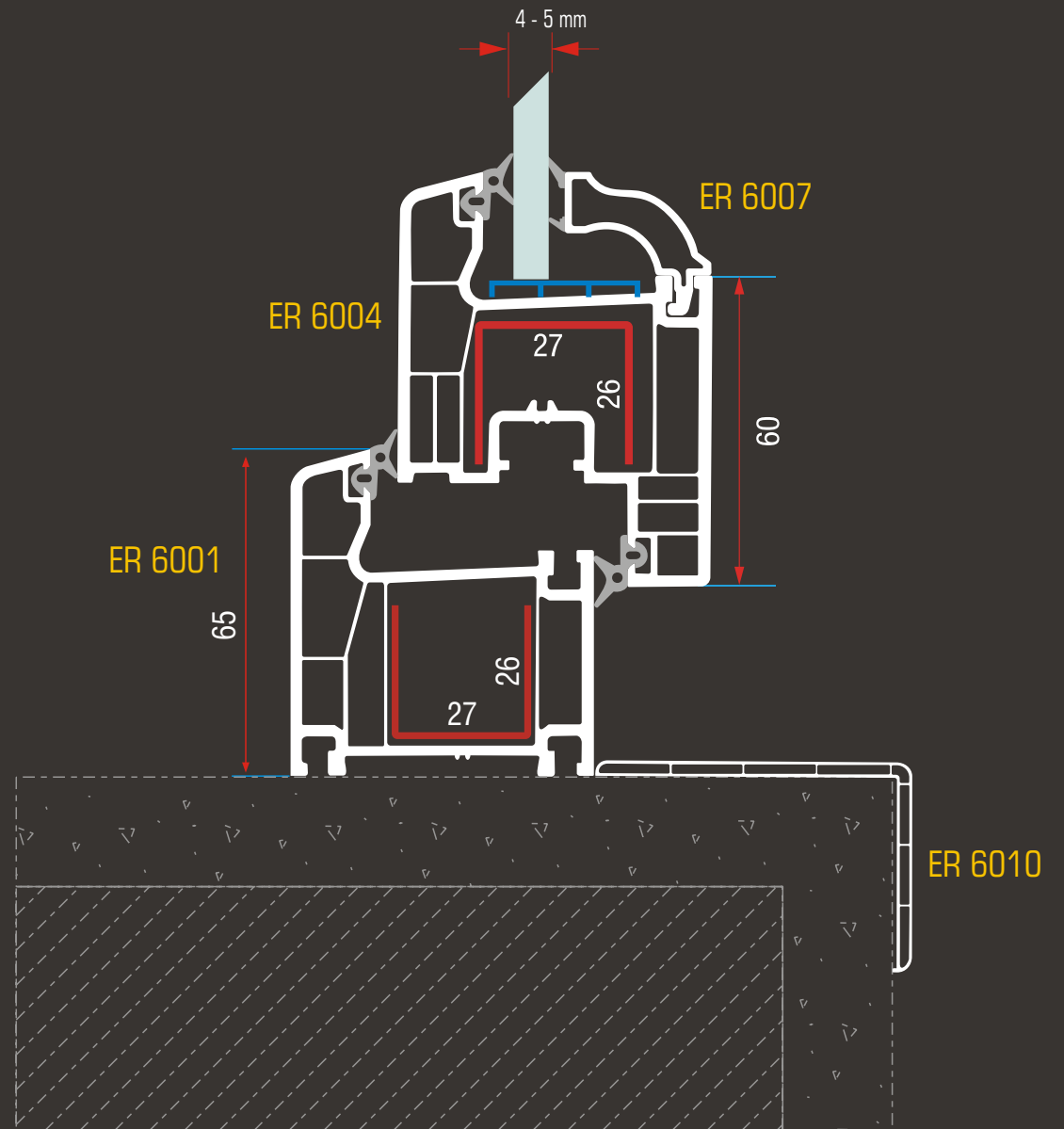
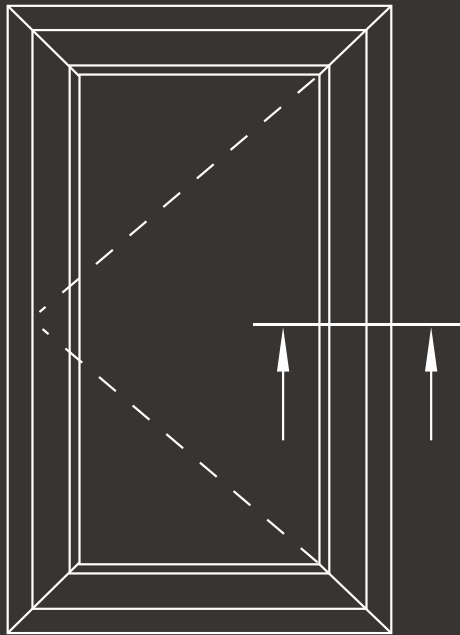

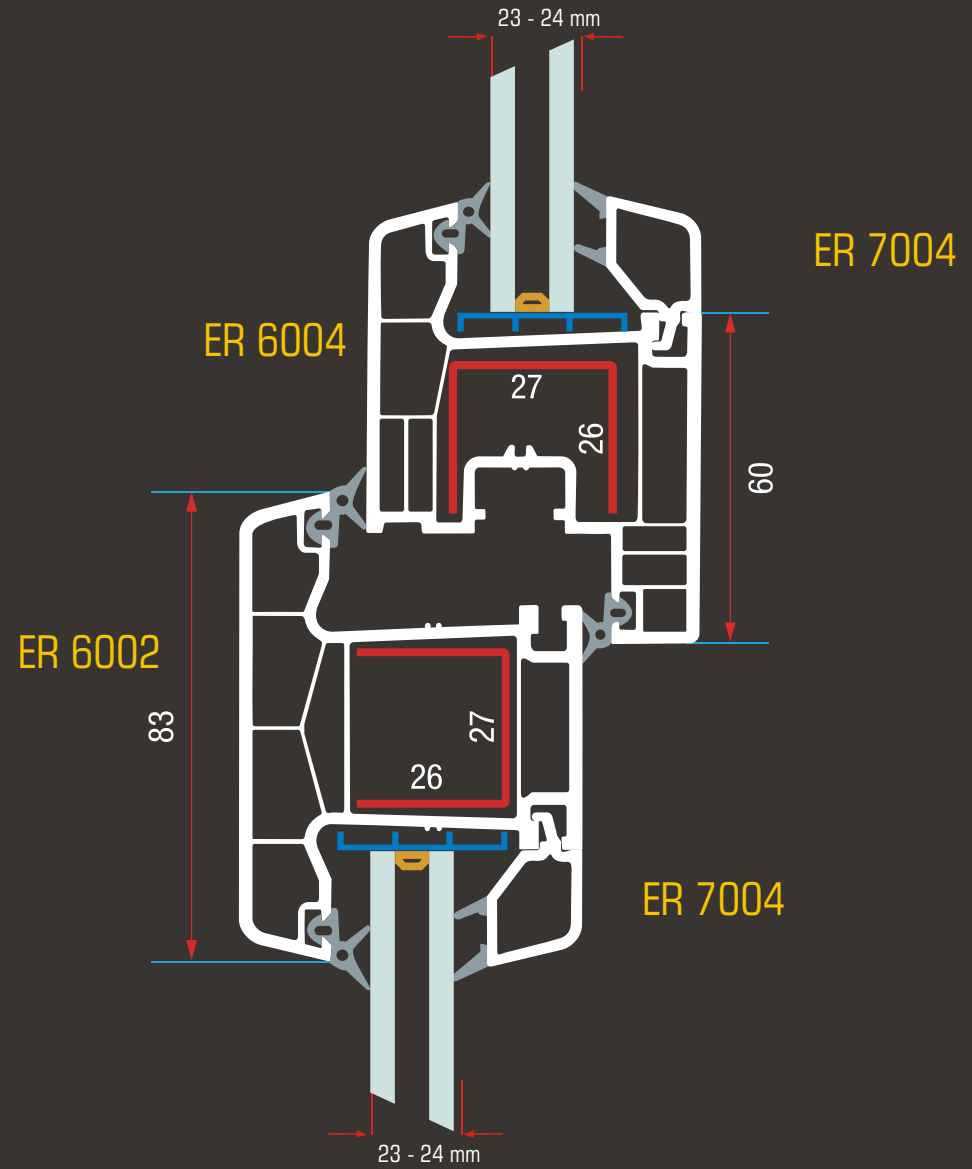
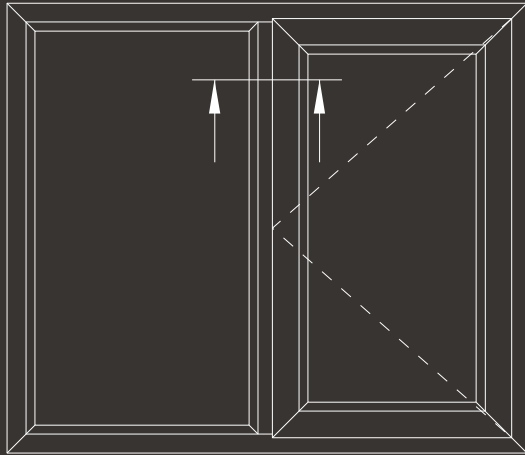

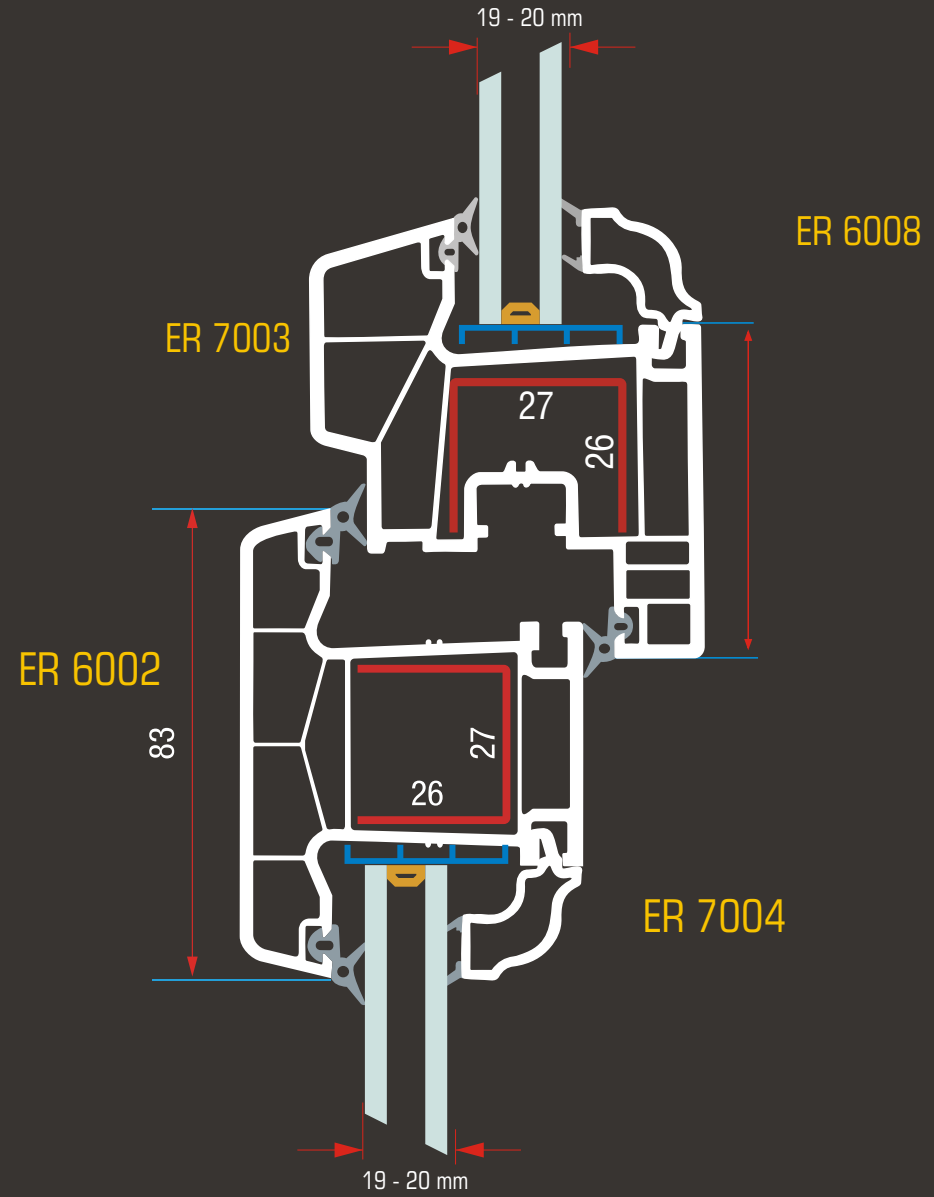
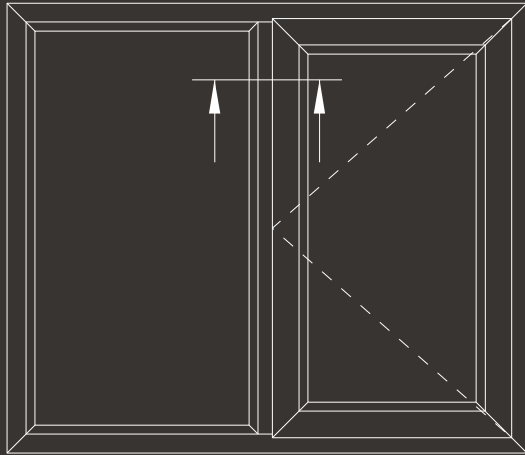

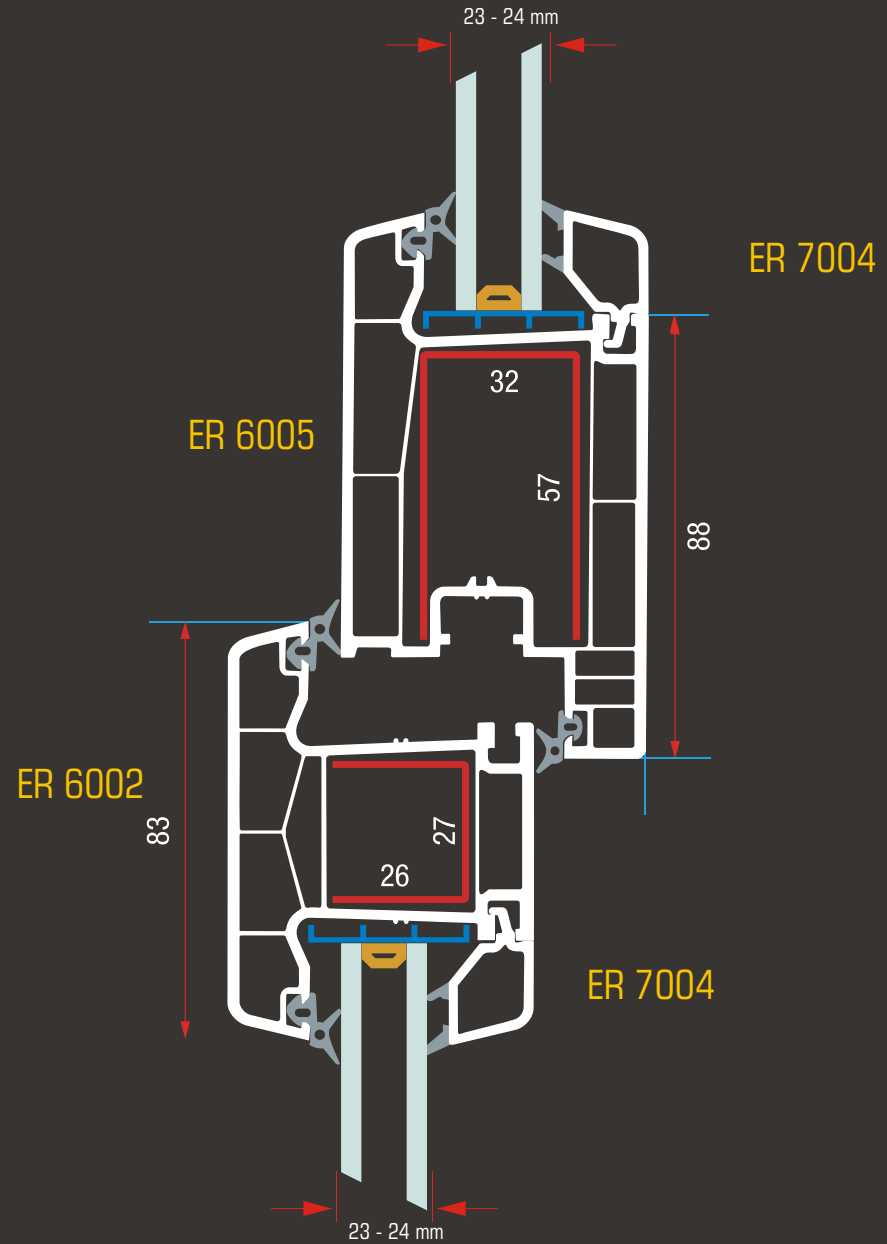
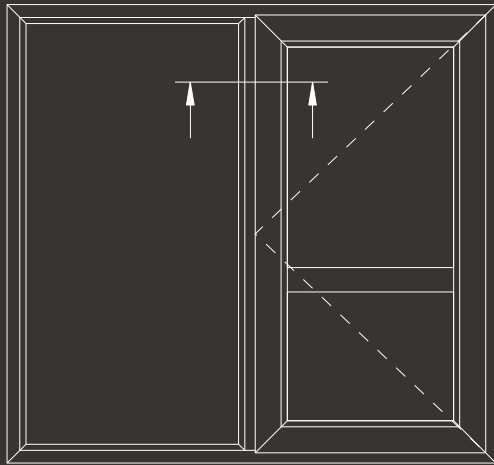

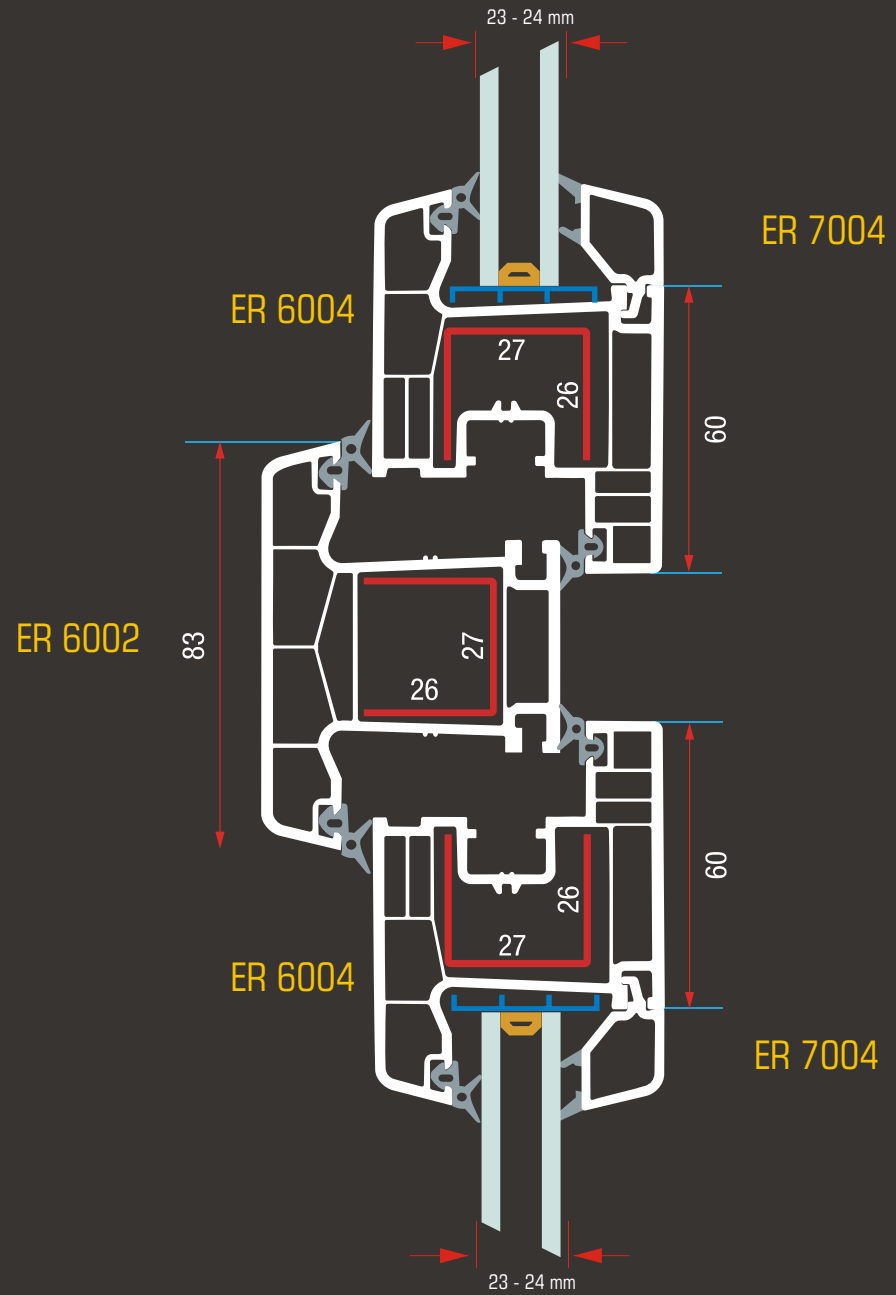
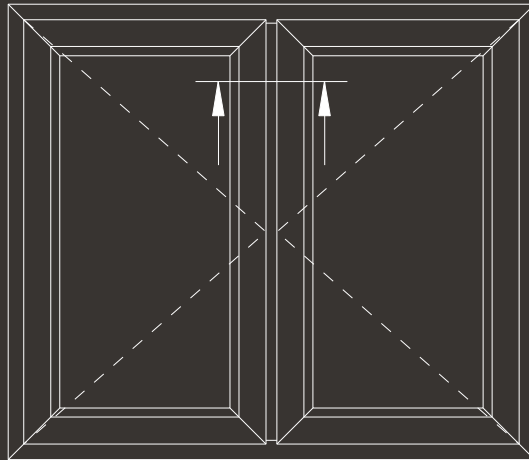

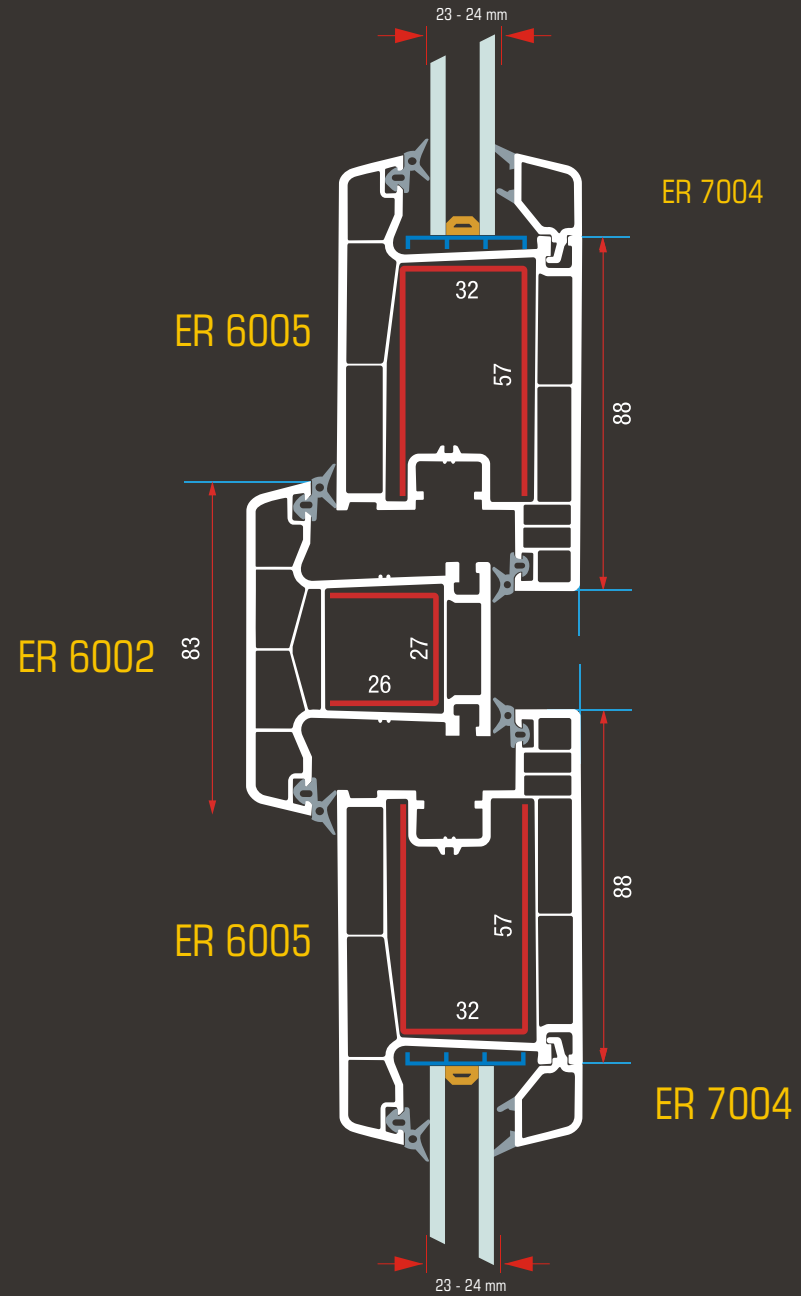
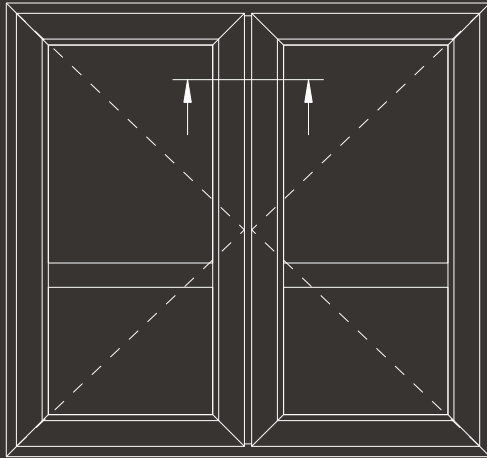

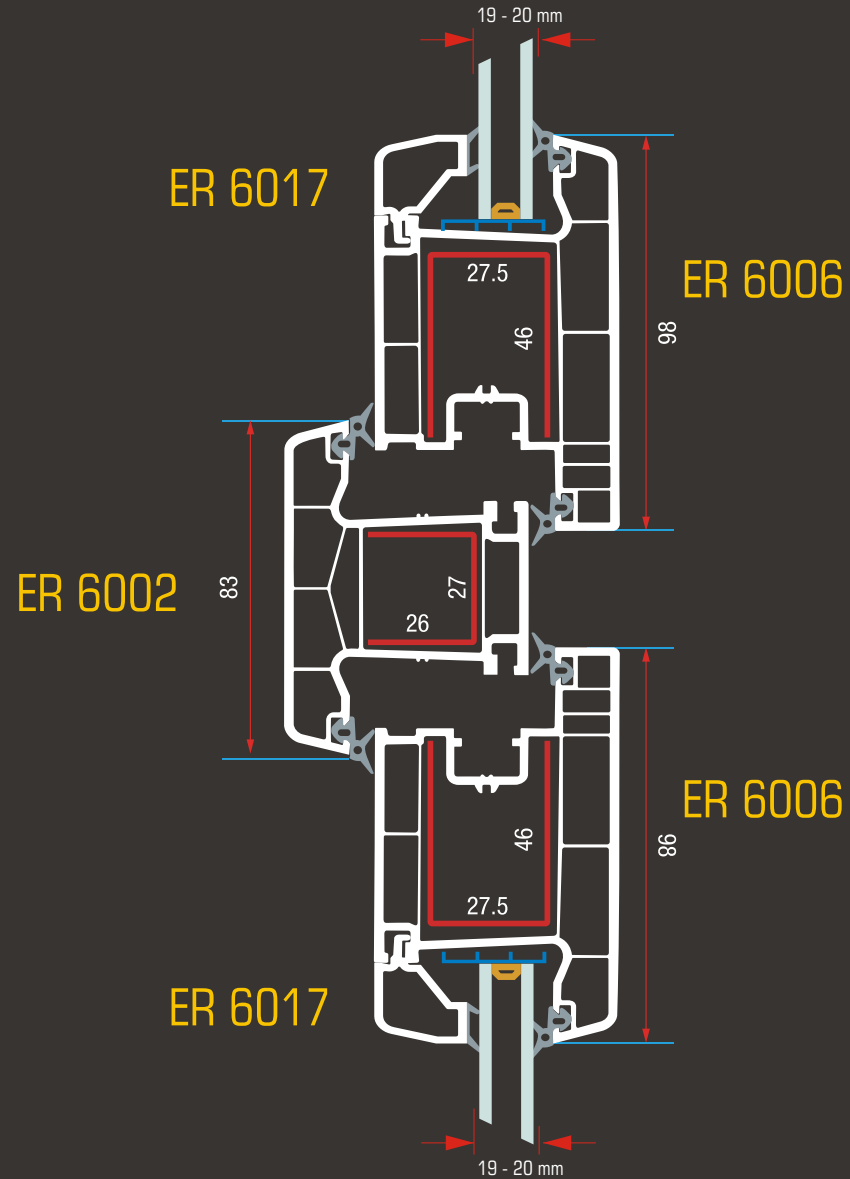
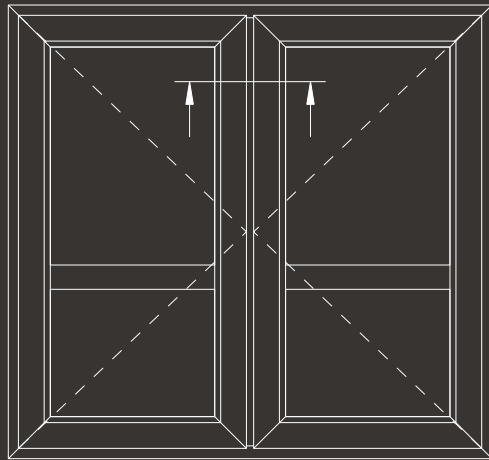

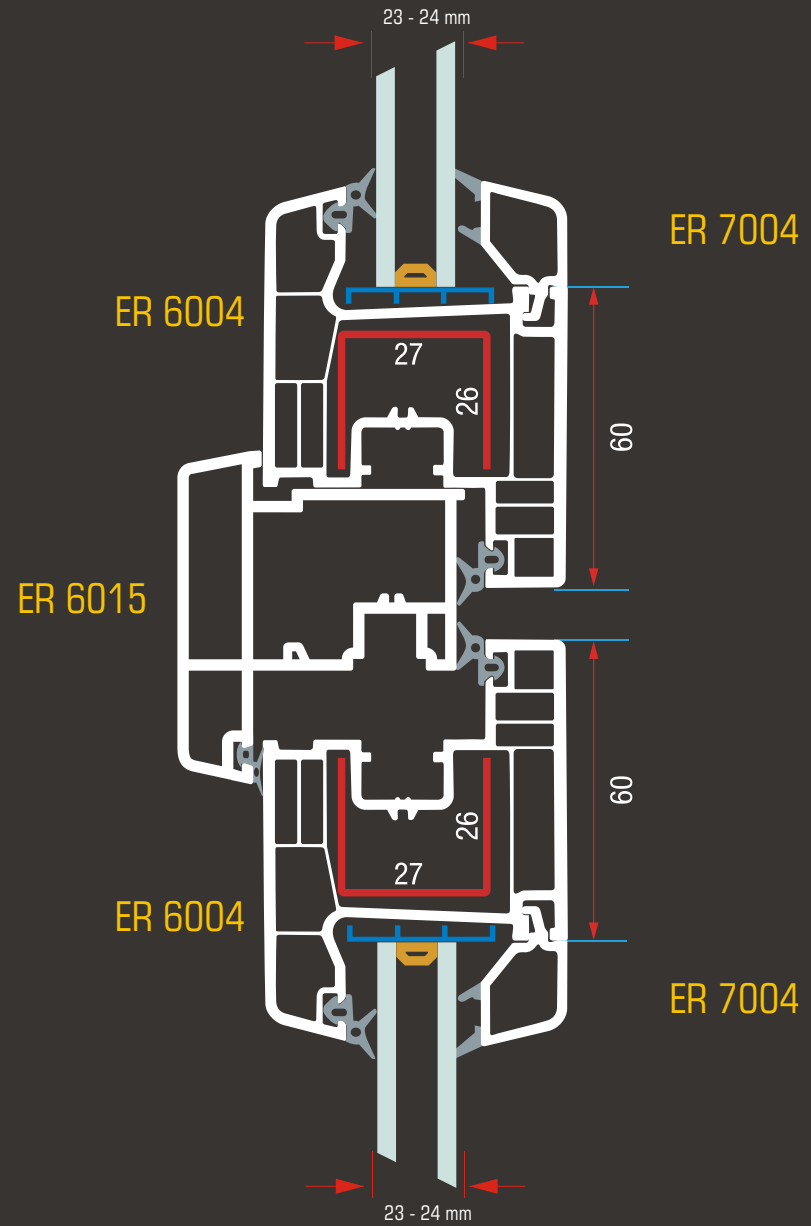
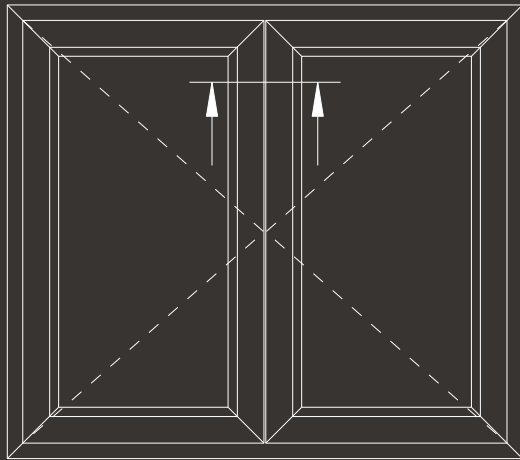

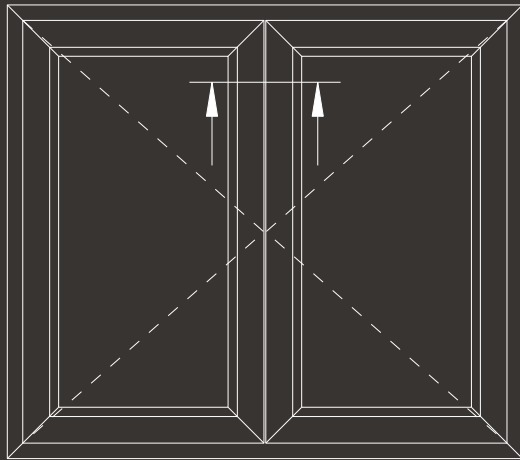

ER 6015

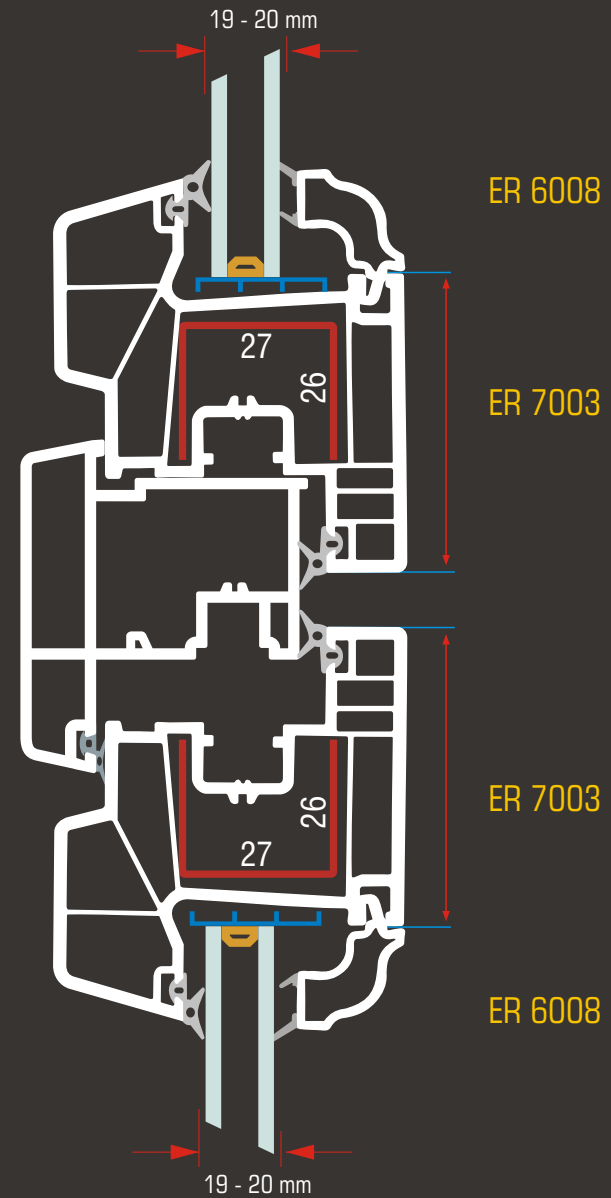

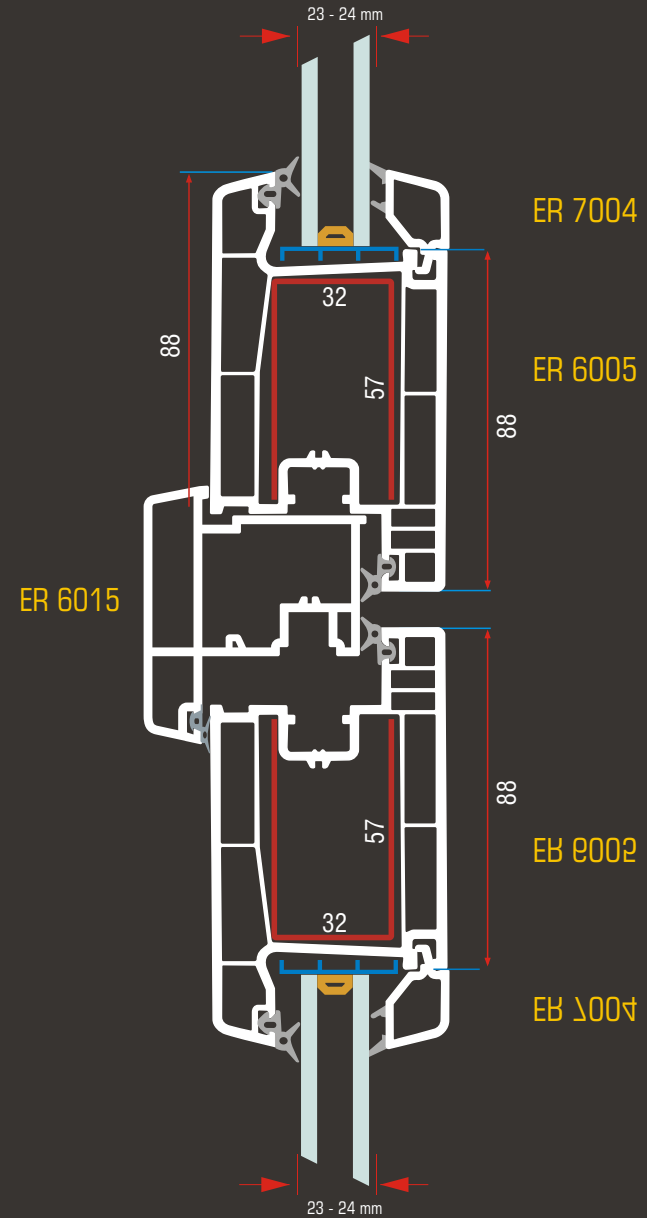
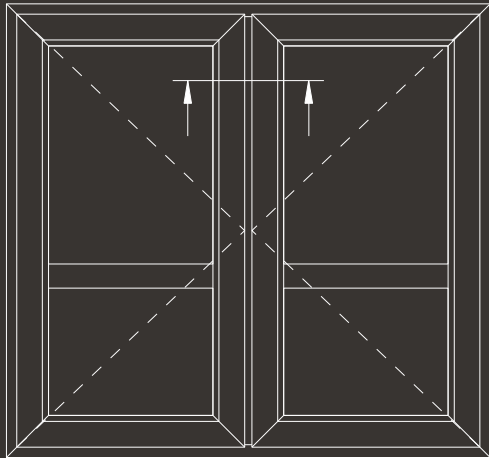

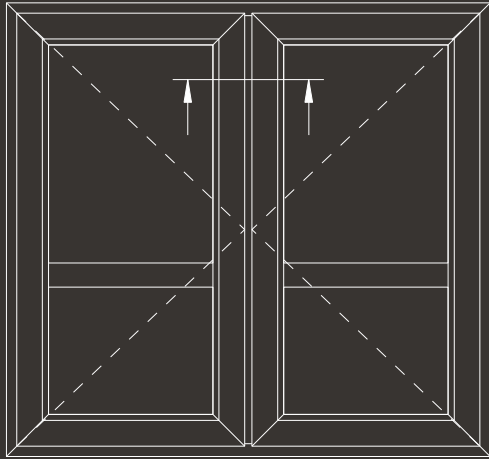

ER 6015

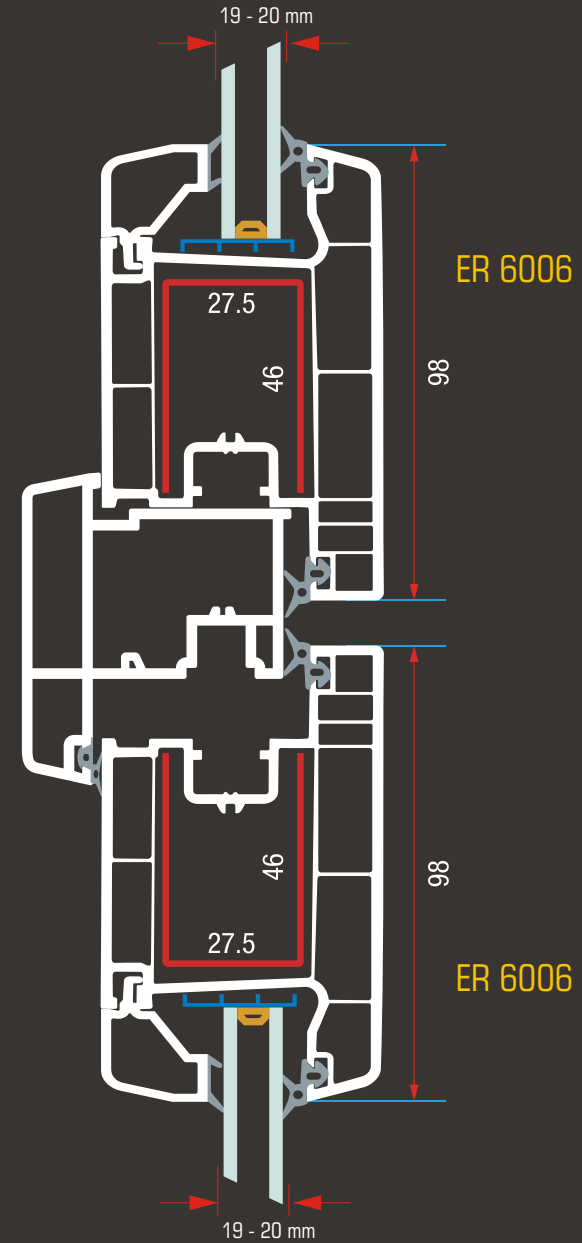

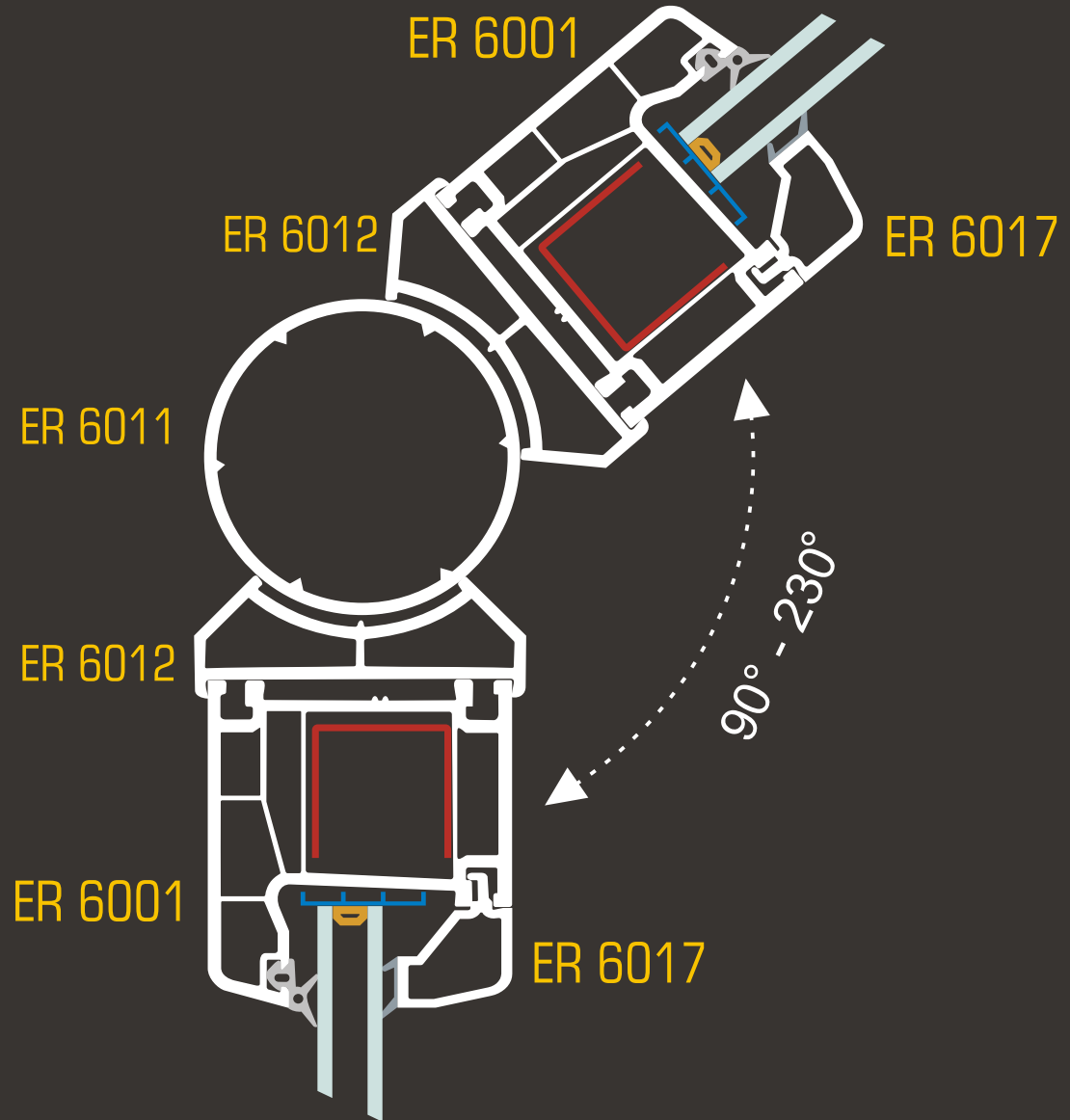
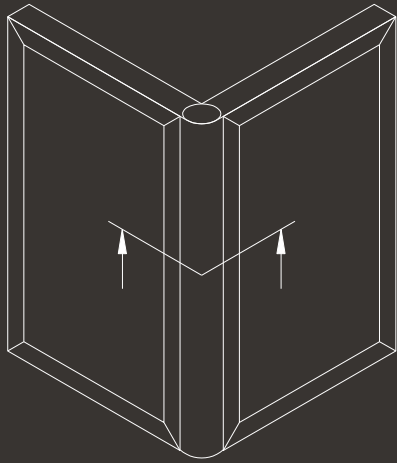

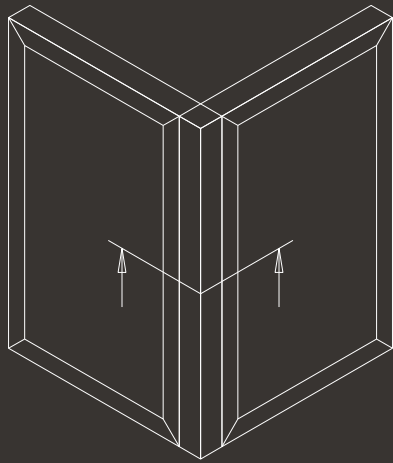

ER 6014

ER 6001

ER 6001

ER 6017

ER 6017

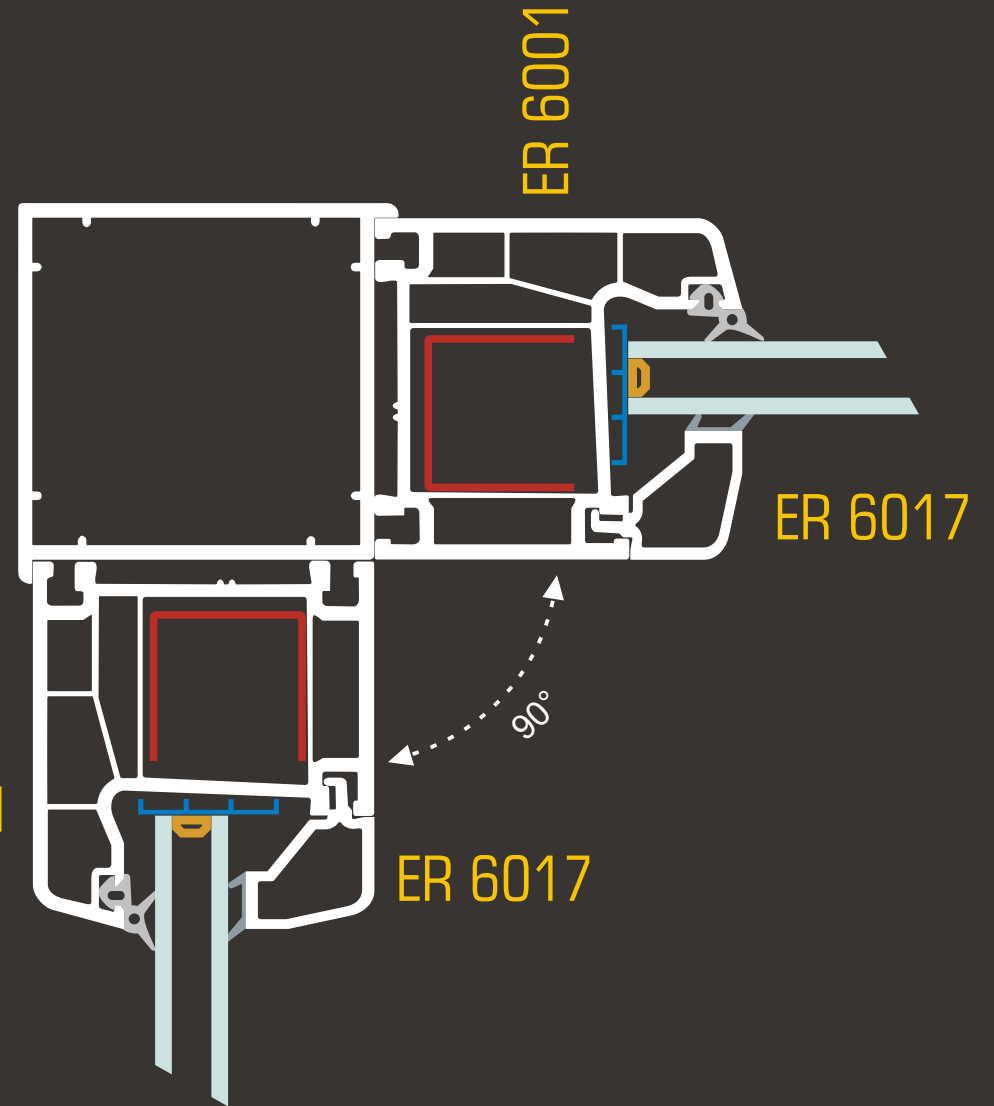

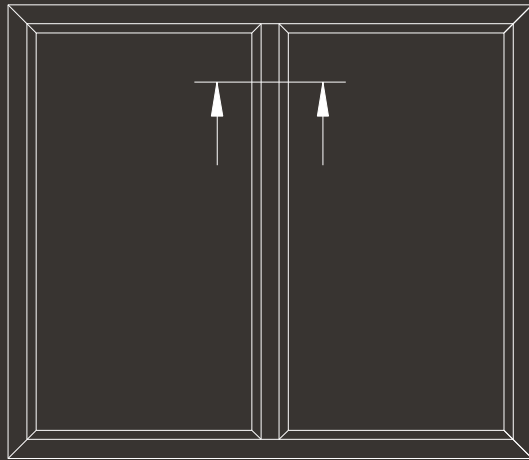

ER 6017

ER 6001

ER 6013

ER 6001

ER 6017

